

Description

The AP7312 is 150mA, dual fixed output voltage, low dropout linear regulator. The AP7312 include the pass element, error amplifier, band-gap, current limit and thermal shutdown circuitry which protect the IC from damage in fault conditions. The AP7312 has two enable pins (EN1 and EN2) to independently turn the respective channel on when a logic high level is applied.

The characteristics of low dropout voltage and low quiescent current make it suitable for low power applications. The typical quiescent current is approximately 60 μ A.

This device is available with fixed output options of 1.2V/1.8V, 1.2V/3.3V, 1.5V/2.5V, 1.5V/3.3V, 1.8V/2.8V, 1.8V/3.0V, 1.8V/3.3V and 3.3V/3.3V.

For other output options please contact our local sales representative directly or through our distributor located in your area.

The AP7312 is available in SOT26 and DFN2018-6 packages.

Features

- 150mA Low Dropout Regulator with EN
- Very low IQ: 60 μ A
- Wide input voltage range: 2V to 6V
- Fixed output options: 1.2V to 3.3V
- High PSRR: 65dB at 1kHz
- Fast start-up time: 60 μ s
- Stable with low ESR, 1 μ F ceramic output capacitor
- Excellent Load/Line Transient Response
- Low dropout: 150mV at 150mA
- Current limit protection
- Short circuit protection
- Thermal shutdown protection
- Ambient temperature range: -40°C to 85°C
- SOT26 and DFN2018-6: Available in "Green" Molding Compound (No Br, Sb)
- Lead Free Finish/RoHS Compliant (Note 1)

Note: 1. EU Directive 2002/95/EC (RoHS). All applicable RoHS exemptions applied. Please visit our website at http://www.diodes.com/products/lead_free.html.

Pin Assignments

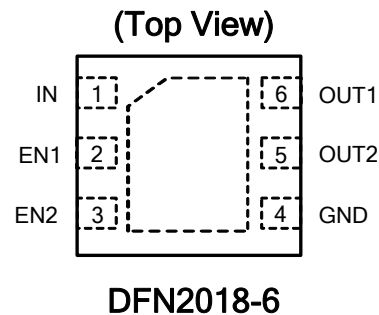
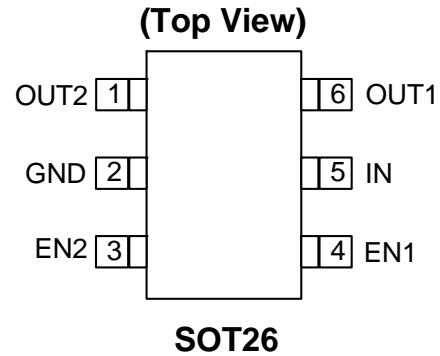

Applications

- Cellular Phones
- Smart Phones, PDAs
- MP3/MP4
- Bluetooth head set
- Low power application

Typical Application Circuit

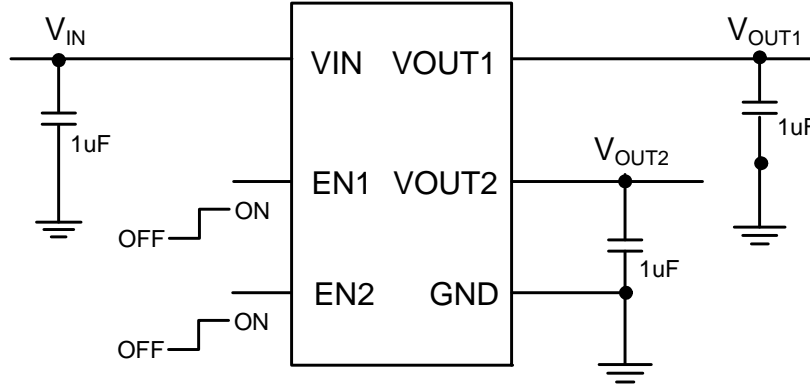

Pin Descriptions

Pin Name	Pin Number		Description
	SOT26	DFN2018-6	
OUT2	1	5	Voltage output 2. Bypass to ground through 1µF ceramic capacitor
GND	2	4	Ground
EN2	3	3	Enable input 2, active high
EN1	4	2	Enable input 1, active high
IN	5	1	Voltage input. Bypass to ground through at least 1µF capacitor
OUT1	6	6	Voltage output 1. Bypass to ground through 1µF ceramic capacitor

NEW PRODUCT

Functional Block Diagram

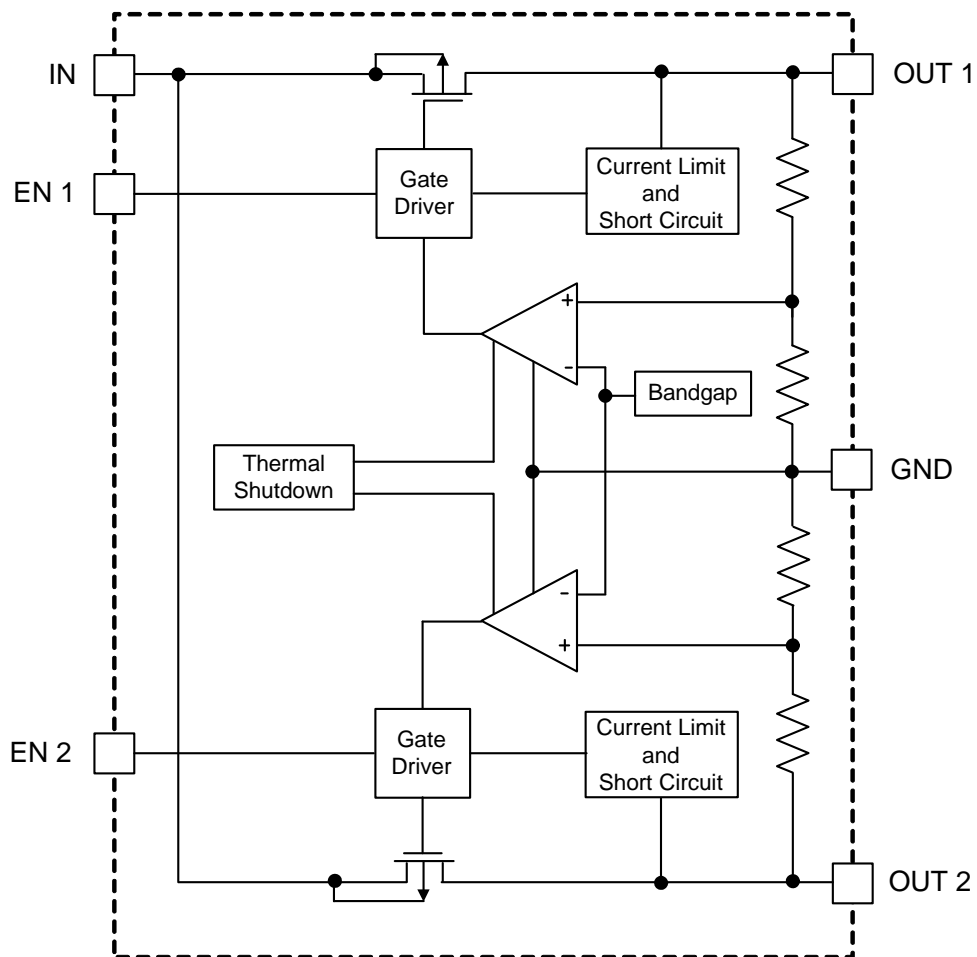

NEW PRODUCT

DUAL 150mA LOW QUIESCENT CURRENT FAST TRANSIENT LOW DROPOUT LINEAR REGULATOR

Absolute Maximum Ratings

Symbol	Parameter	Ratings	Unit	
ESD HBM	Human Body Model ESD Protection	8	kV	
ESD MM	Machine Model ESD Protection	400	V	
V_{IN}	Input Voltage	6.5	V	
	OUT, EN Voltage	$V_{IN} + 0.3$	V	
	Continuous Load Current	Internal Limited		
T_{OP}	Operating Junction Temperature Range	-40 ~ 125	°C	
T_{ST}	Storage Temperature Range	-65 ~ 150	°C	
P_D	Power Dissipation (Note 3)	SOT26	950	mW
		DFN2018-6	2200	mW
T_J	Maximum Junction Temperature	150	°C	

Recommended Operating Conditions

Symbol	Parameter	Min	Max	Unit
V_{IN}	Input voltage	2	6	V
I_{OUT}	Output Current (Note 3)	0	150	mA
T_A	Operating Ambient Temperature	-40	85	°C

Notes: 2. Ratings apply to ambient temperature at 25°C.
3. The device maintains a stable, regulated output voltage without a load current.

DUAL 150mA LOW QUIESCENT CURRENT FAST TRANSIENT LOW DROPOUT LINEAR REGULATOR

Electrical Characteristics

($T_A = 25^\circ\text{C}$, $V_{IN} = V_{OUT} + 1\text{V}$, $C_{IN} = 1\mu\text{F}$, $C_{OUT} = 1\mu\text{F}$, $V_{EN} = V_{IN}$, unless otherwise stated)

Symbol	Parameter	Test Conditions	Min	Typ.	Max	Unit
V_{REF}	ADJ Reference Voltage (Adjustable version)	$I_{OUT} = 0\text{mA}$		0.8		V
I_{ADJ}	ADJ Leakage (Adjustable version)			0.1	1	μA
V_{OUT}	Output Voltage Accuracy	$T_A = -40^\circ\text{C}$ to 85°C , $I_{OUT} = 10\%$ of $I_{OUT-Max}$	-2		2	%
$\Delta V_{OUT} / \Delta V_{IN} / V$	Line Regulation	$V_{IN} = (V_{OUT} + 1\text{V})$ to V_{IN-Max} , $V_{EN} = V_{IN}$, $I_{OUT} = 1\text{mA}$		0.01	0.20	%/V
$\Delta V_{OUT} / I_{OUT}$	Load Regulation	$V_{IN} = (V_{OUT} + 1\text{V})$ to V_{IN-Max} , $I_{OUT} = 1\text{mA}$ to 150mA	-0.6		0.6	%
$V_{Dropout}$	Dropout Voltage (Note 4)	$V_{OUT} < 2.5\text{V}$, $I_{OUT} = 150\text{mA}$ $V_{OUT} \geq 2.5\text{V}$, $I_{OUT} = 150\text{mA}$		200 150	300 200	mV
I_Q	Input Quiescent Current (2 channels)	$V_{EN} = V_{IN}$, $I_{OUT} = 0\text{mA}$		60	80	μA
I_{SHDN}	Input Shutdown Current	$V_{EN} = 0\text{V}$, $I_{OUT} = 0\text{mA}$		0.1	1	μA
I_{LEAK}	Input Leakage Current	$V_{EN} = 0\text{V}$, OUT grounded		0.1	1	μA
t_{ST}	Start-up Time	$V_{EN} = 0\text{V}$ to 2.0V in $1\mu\text{s}$, $I_{OUT} = 150\text{mA}$		150		μs
PSRR	PSRR (Note 5)	$V_{IN} = [V_{OUT} + 1\text{V}]V_{DC} + 0.5V_{ppAC}$, $f = 1\text{kHz}$, $I_{OUT} = 50\text{mA}$	60	65		dB
I_{SHORT}	Short-circuit Current	$V_{IN} = V_{IN-Min}$ to V_{IN-Max} , $V_{OUT} = 1/4$ target V_{OUT}		60		mA
I_{LIMIT}	Current limit	$V_{IN} = V_{IN-Min}$ to V_{IN-Max} , $V_{OUT}/R_{OUT} = 0.6\text{A}$	200	300		mA
V_{IL}	EN Input Logic Low Voltage	$V_{IN} = V_{IN-Min}$ to V_{IN-Max}			0.4	V
V_{IH}	EN Input Logic High Voltage	$V_{IN} = V_{IN-Min}$ to V_{IN-Max}	1.4			V
I_{EN}	EN Input Current	$V_{IN} = 0\text{V}$ or V_{IN-Max}	-1		1	μA
T_{SHDN}	Thermal shutdown threshold			165		$^\circ\text{C}$
T_{HYS}	Thermal shutdown hysteresis			30		$^\circ\text{C}$
θ_{JA}	Thermal Resistance Junction-to-Ambient	SOT26 (Note 6) DFN2018-6 (Note 7)		140 60		$^\circ\text{C}/\text{W}$

- Notes:
- Dropout voltage is the voltage difference between the input and the output at which the output voltage drops 2% below its nominal value.
 - This specification is guaranteed by design.
 - Test condition for SOT26: Device mounted on FR-4 substrate PC board, with minimum recommended pad layout
 - Test condition for DFN2018-6: Device mounted on FR-4 2-layer board, 2oz copper, with minimum recommended pad on top layer and 3 vias to bottom layer.

Typical Performance Characteristics

NEW PRODUCT

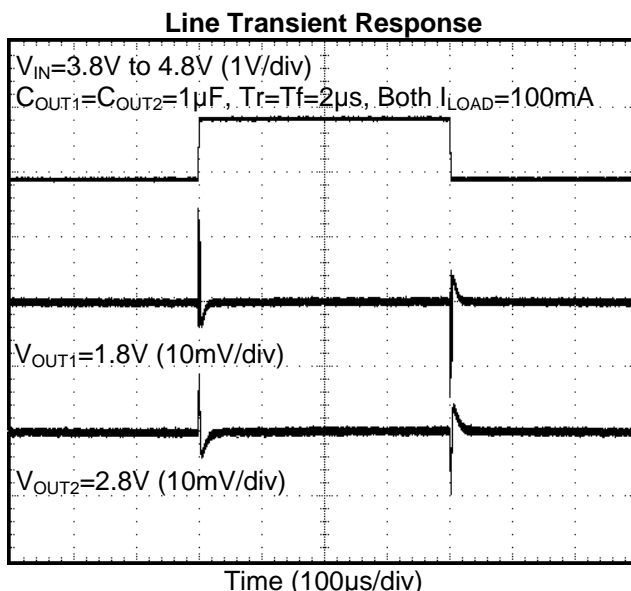
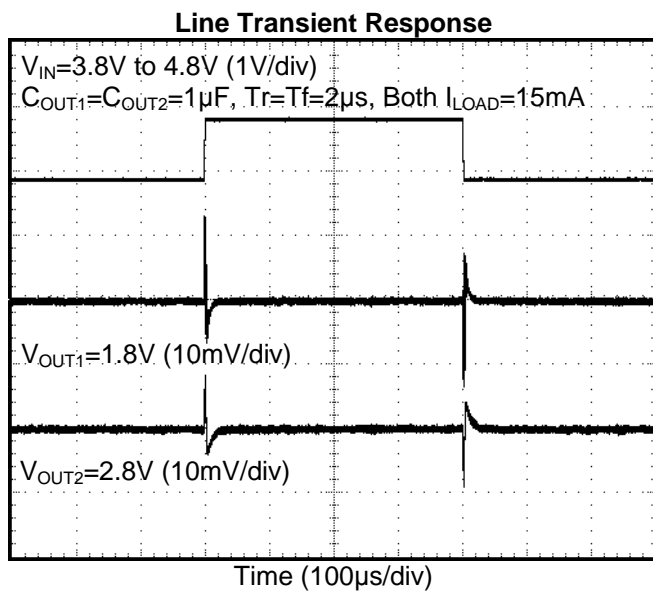
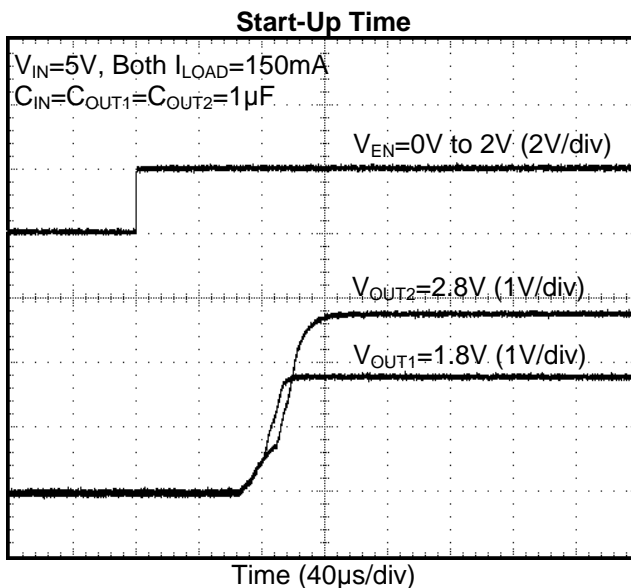
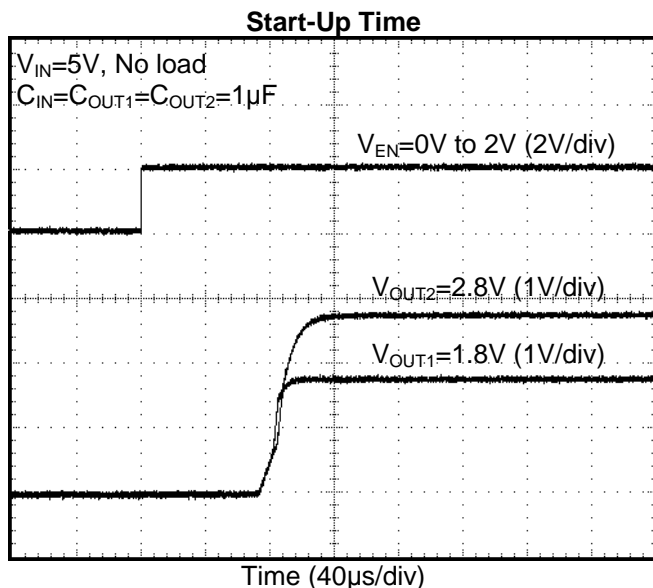

Typical Performance Characteristics (Continued)

Load Transient Response

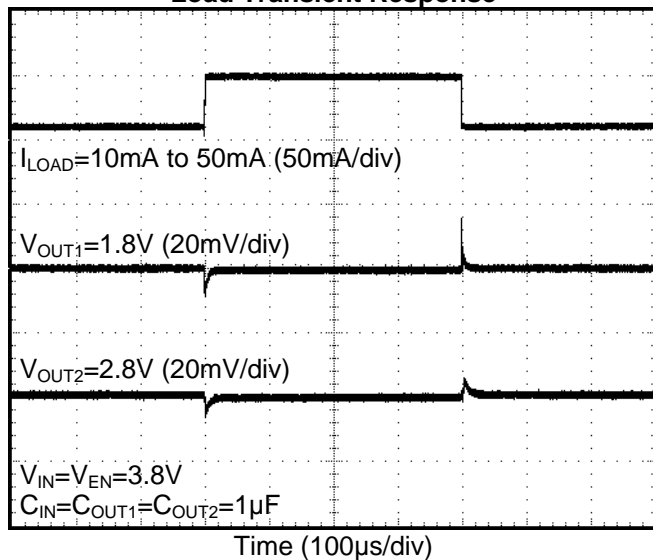

Load Transient Response

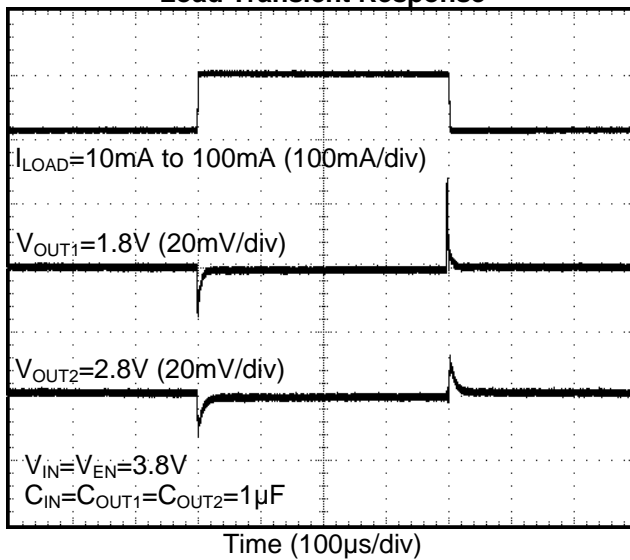

EN1 Pin Response

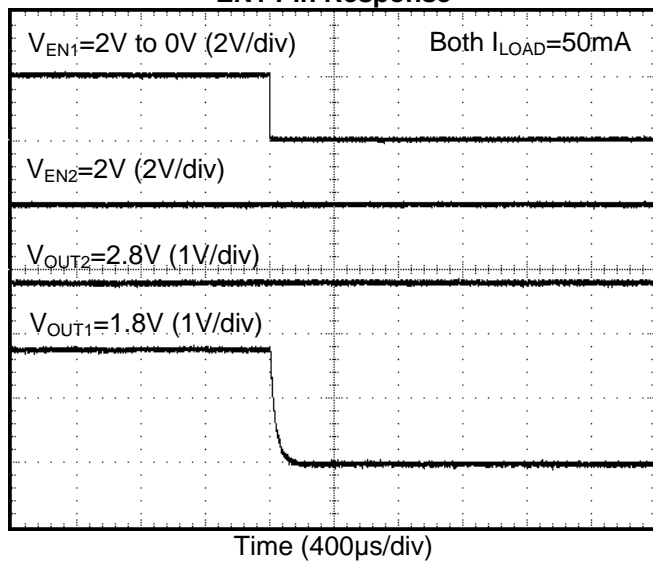

EN2 Pin Response

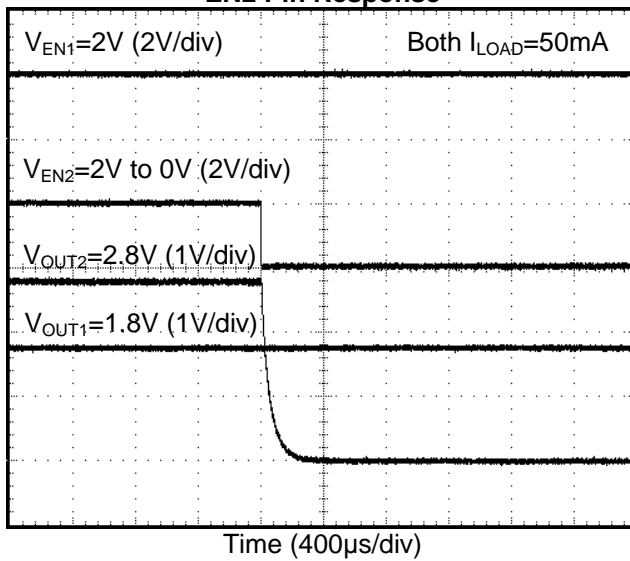

NEW PRODUCT

Typical Performance Characteristics (Continued)

EN Pin Shutdown Response

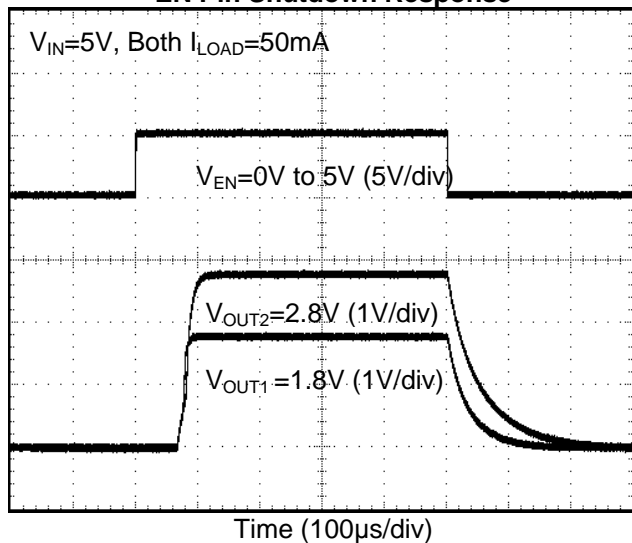

PSRR vs Frequency

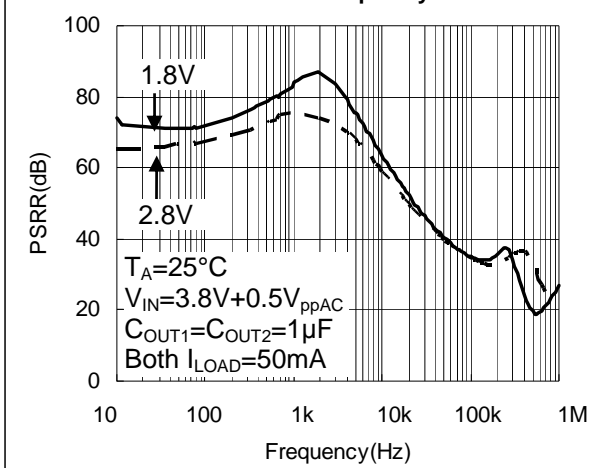

Input Quiescent current vs Input Voltage

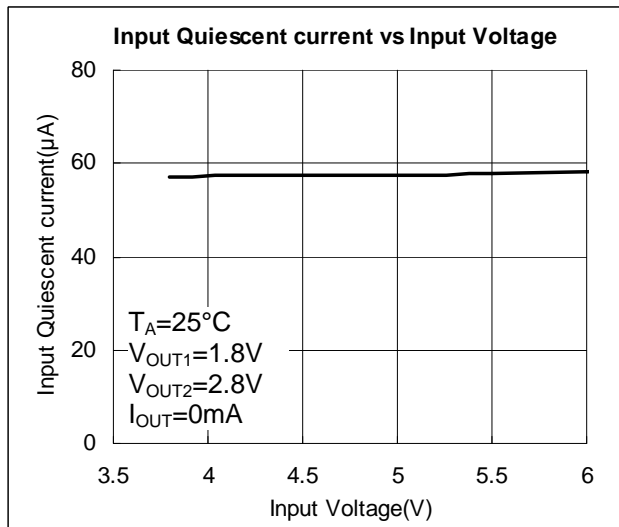

Input Quiescent current vs Temperature

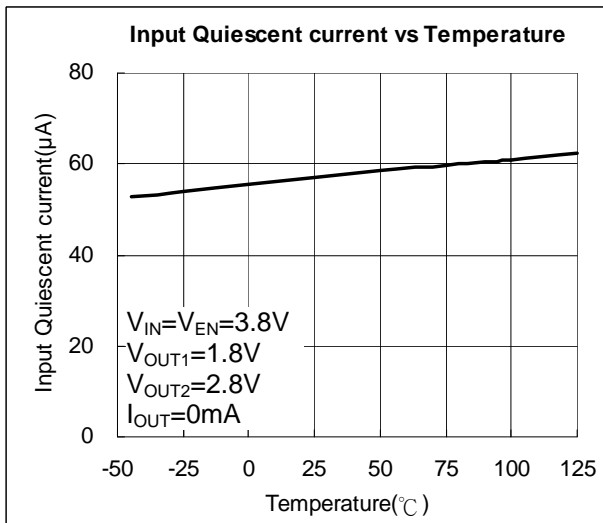

Typical Performance Characteristics (Continued)

NEW PRODUCT

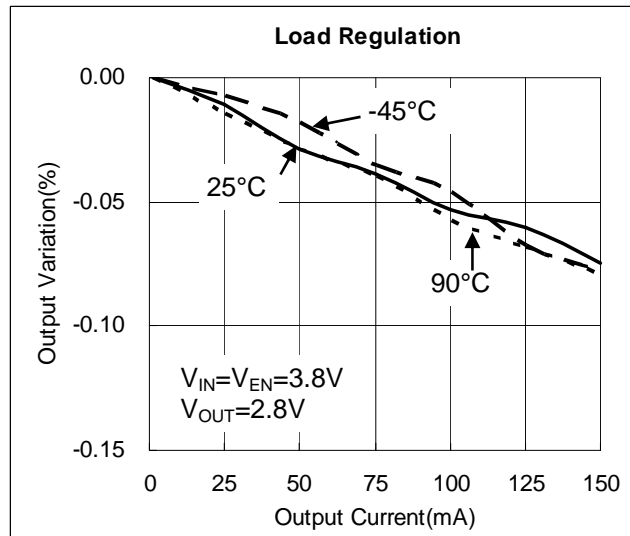
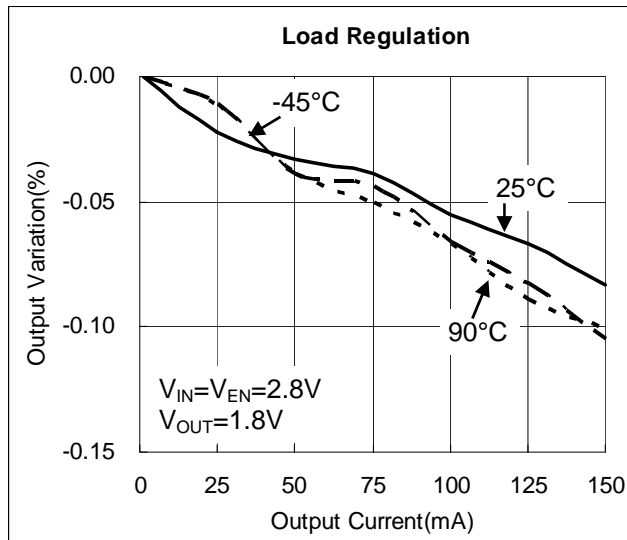
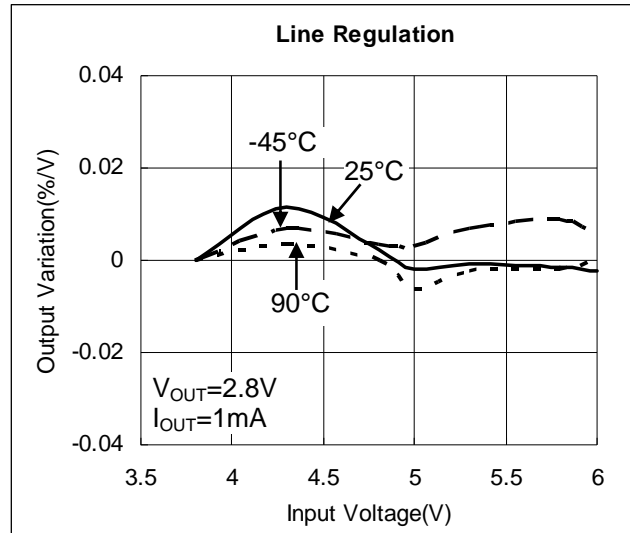
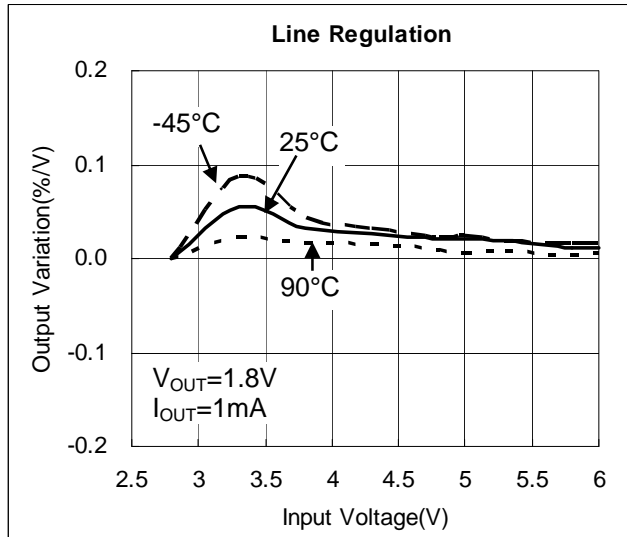

Typical Performance Characteristics (Continued)

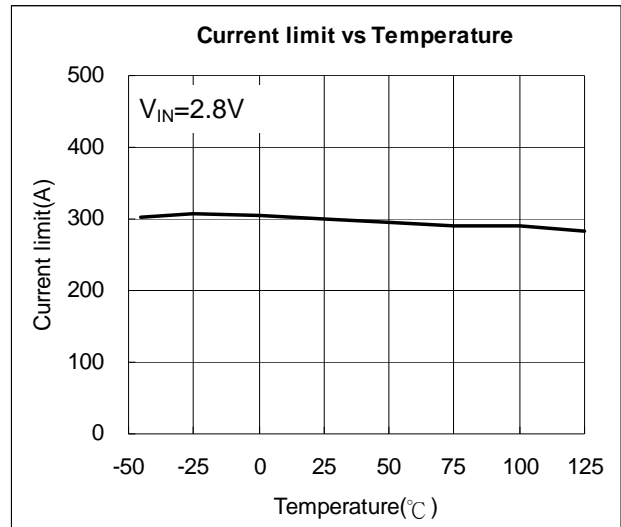
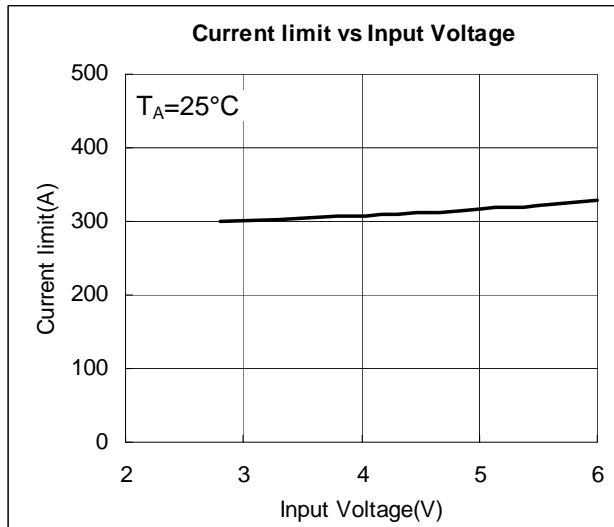
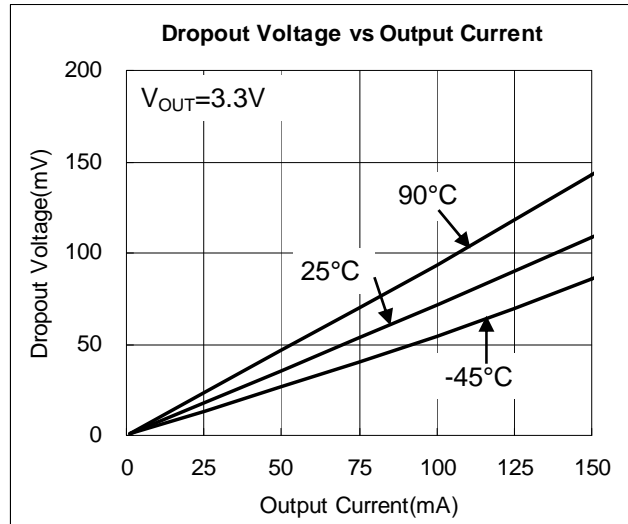
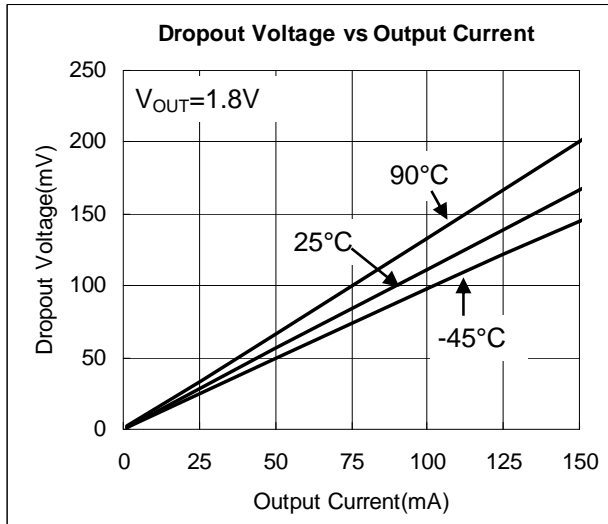

Typical Performance Characteristics (Continued)

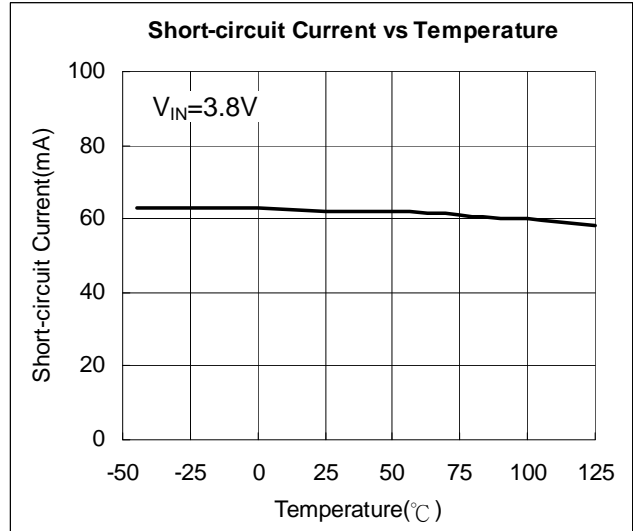
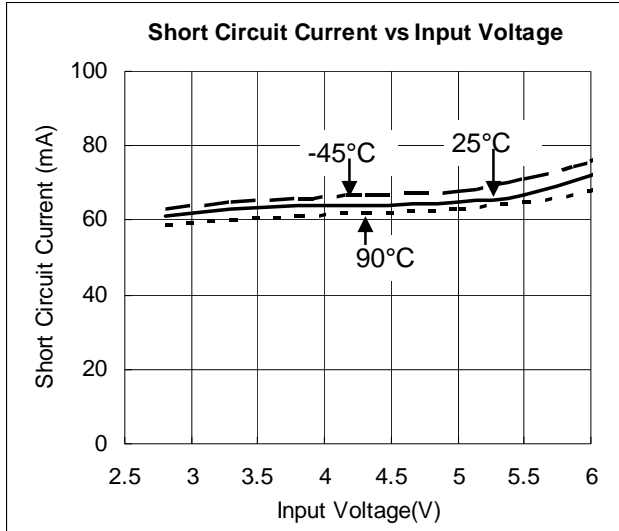

NEW PRODUCT

Application Note

Input Capacitor

A 1µF ceramic capacitor is recommended between IN and GND pins to decouple input power supply glitch and noise. The amount of the capacitance may be increased without limit. This input capacitor must be located as close as possible to the device to assure input stability and reduce noise. For PCB layout, a wide copper trace is required for both IN and GND pins. A lower ESR capacitor type allows the use of less capacitance, while higher ESR type requires more capacitance.

Output Capacitor

The output capacitor is required to stabilize and improve the transient response of the LDO. The AP7312 is stable with very small ceramic output capacitors. Using a ceramic capacitor value that is at least 1µF with ESR≥10mΩ on the output ensures stability. Higher capacitance values help to improve line and load transient response. The output capacitance may be increased to keep low undershoot and overshoot. Output capacitor must be placed as close as possible to OUT and GND pins.

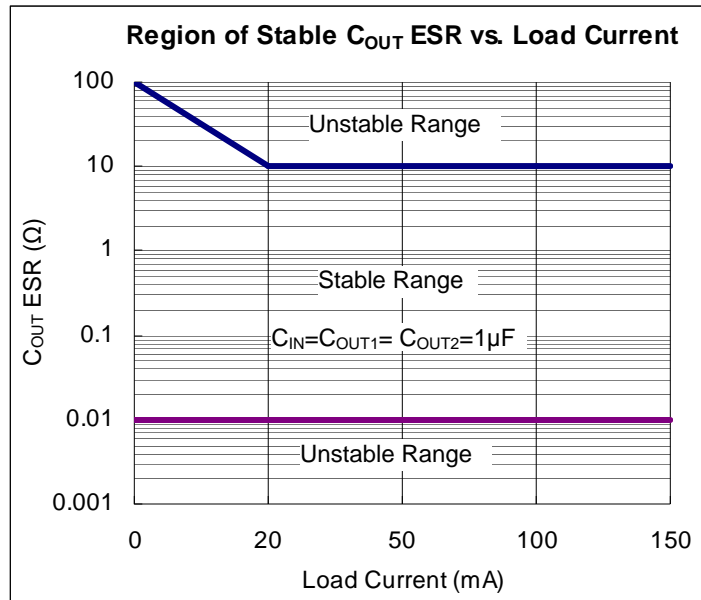

No Load Stability

Other than external resistor divider, no minimum load is required to keep the device stable. The device will remain stable and regulated in no load condition.

ON/OFF Input Operation

The AP7312 is turned on by setting the EN pin high, and is turned off by pulling it low. If this feature is not used, the EN pin should be tied to IN pin to keep the regulator output on at all time. To ensure proper operation, the signal source used to drive the EN pin must be able to swing above and below the specified turn-on/off voltage thresholds listed in the Electrical Characteristics section under V_{IL} and V_{IH}.

NEW PRODUCT

Application Note (Continued)

Current Limit Protection

When output current at OUT pin is higher than current limit threshold, the current limit protection will be triggered and clamp the output current to approximately 300mA to prevent over-current and to protect the regulator from damage due to overheating.

Short Circuit Protection

When OUT pin is short-circuit to GND, short circuit protection will be triggered and clamp the output current to approximately 60mA. This feature protects the regulator from over-current and damage due to overheating.

Thermal Shutdown Protection

Thermal protection disables the output when the junction temperature rises to approximately +165°C, allowing the device to cool down. When the junction temperature reduces to approximately +135°C the output circuitry is enabled again. Depending on power dissipation, thermal resistance, and ambient temperature, the thermal protection circuit may cycle on and off. This cycling limits the heat dissipation of the regulator, protecting it from damage due to overheating.

Ultra Fast Start-up

After enabled, the AP7312 is able to provide full power in as little as tens of microseconds, typically 150µs, without sacrificing low ground current. This feature will help load circuitry move in and out of standby mode in real time, eventually extend battery life for mobile phones and other portable devices.

Fast Transient Response

Fast transient response LDO can extend battery life. TDMA-based cell phone protocols such as Global System for Mobile Communications (GSM) have a transmit/receive duty factor of only 12.5 percent, enabling power savings by putting much of the baseband circuitry into standby mode in between transmit cycles. In baseband circuits, the load often transitions virtually instantaneously from 100µA to 100mA. To meet this load requirement, the LDO must react very quickly without a large voltage drop or overshoot — a requirement that cannot be met with conventional, general-purpose LDO.

The AP7312's fast transient response from 0 to 150mA provides stable voltage supply for fast DSP and GSM chipset with fast changing load.

Low Quiescent Current

The AP7312, consuming only around 60µA for all input range, provides great power saving in portable and low power applications.

Power Dissipation

The device power dissipation and proper sizing of the thermal plane that is connected to the thermal pad is critical to avoid thermal shutdown and ensure reliable operation. Power dissipation of the device depends on input voltage and load conditions and can be calculated by:



$$P_D = (V_{IN} - V_{OUT}) \times I_{OUT}$$

The maximum power dissipation, handled by the device, depends on the maximum junction to ambient thermal resistance, maximum ambient temperature, and maximum device junction temperature, which can be calculated by the equation in the following:

$$P_D (\text{max}@T_A) = \frac{(+150^\circ\text{C} - T_A)}{R_{\theta JA}}$$

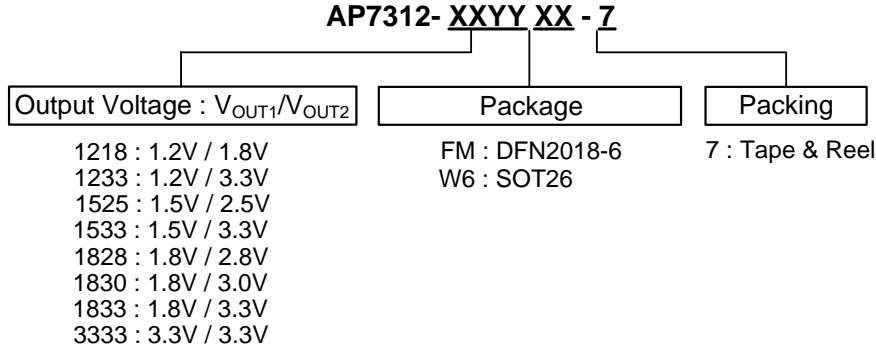
Ordering Information



Device	Package Code	Packaging (Note 8)	7" Tape and Reel	
			Quantity	Part Number Suffix
 AP7312-XXYY W6-7	W6	SOT26	3000/Tape & Reel	-7
 AP7312-XXYY FM-7	FM	DFN2018-6	3000/Tape & Reel	-7

Note: 8. Pad layout as shown on Diodes Inc. suggested pad layout document AP02001, which can be found on our website at <http://www.diodes.com/datasheets/ap02001.pdf>.

NEW PRODUCT

Marking Information

(1) SOT26

(Top View)

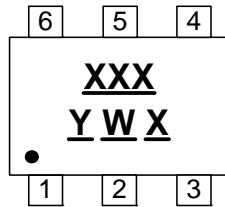

XXX : Identification code
Y : Year 0~9
W : Week : A~Z : 1~26 week;
a~z : 27~52 week; z represents 52 and 53 week
X : A~Z : Internal Code

(2) DFN2018-6

(Top View)

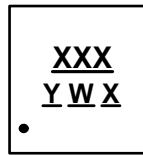

XXX : Identification code
Y : Year : 0~9
W : Week : A~Z : 1~26 week;
a~z : 27~52 week; z represents 52 and 53 week
X : A~Z : Internal Code

Device	Package	Package	Identification Code
AP7312-1218	SOT26	DFN2018-6	CAS
AP7312-1233	SOT26	DFN2018-6	CAZ
AP7312-1525	SOT26	DFN2018-6	CA6
AP7312-1533	SOT26	DFN2018-6	CBC
AP7312-1828	SOT26	DFN2018-6	CBK
AP7312-1830	SOT26	DFN2018-6	CBN
AP7312-1833	SOT26	DFN2018-6	CBR
AP7312-3333	SOT26	DFN2018-6	CEA

Package Outline Dimensions (All Dimensions in mm)

(1) SOT26

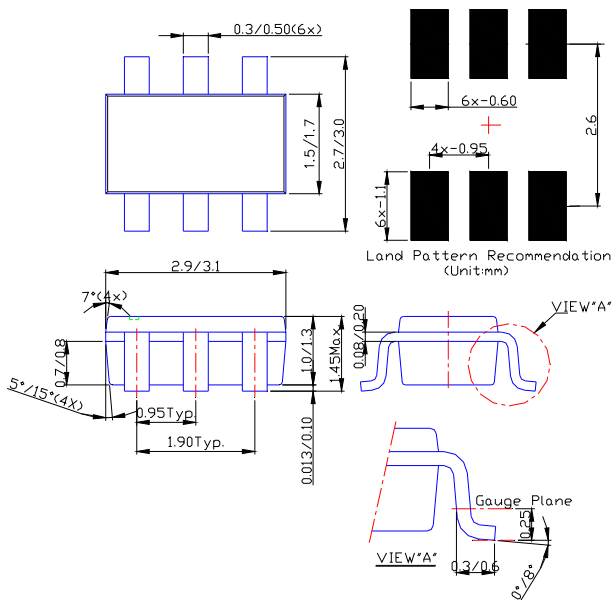

(2) DFN2018-6

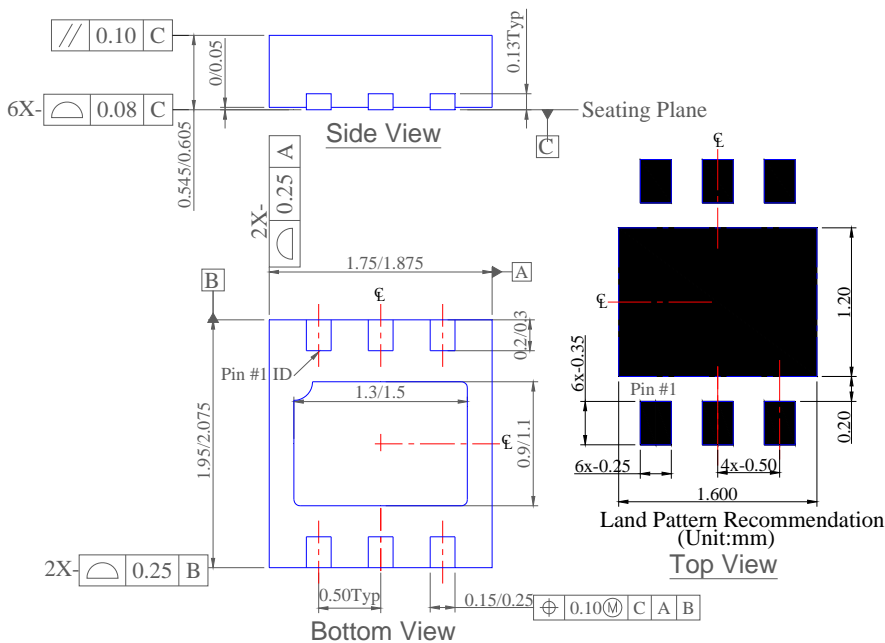

NEW PRODUCT

Taping Orientation (Note 9)

For DFN2018-6

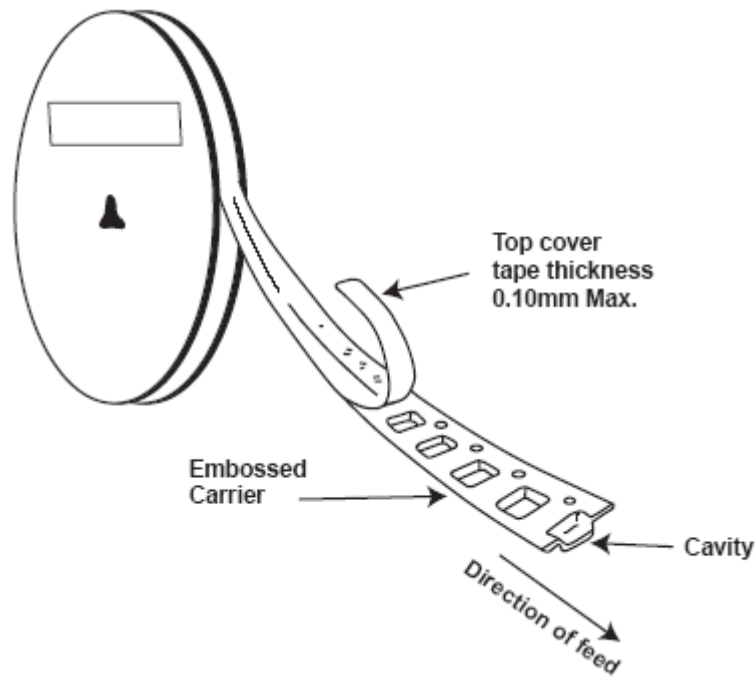
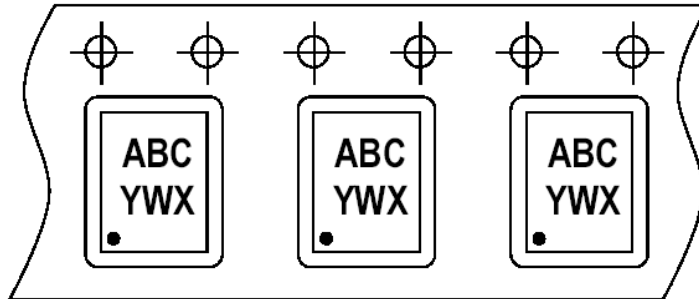

Note: 9. The taping orientation of the other package type can be found on our website at <http://www.diodes.com/datasheets/ap02007.pdf>

NEW PRODUCT

**DUAL 150mA LOW QUIESCENT CURRENT FAST
TRANSIENT LOW DROPOUT LINEAR REGULATOR****IMPORTANT NOTICE**

DIODES INCORPORATED MAKES NO WARRANTY OF ANY KIND, EXPRESS OR IMPLIED, WITH REGARDS TO THIS DOCUMENT, INCLUDING, BUT NOT LIMITED TO, THE IMPLIED WARRANTIES OF MERCHANTABILITY AND FITNESS FOR A PARTICULAR PURPOSE (AND THEIR EQUIVALENTS UNDER THE LAWS OF ANY JURISDICTION).

Diodes Incorporated and its subsidiaries reserve the right to make modifications, enhancements, improvements, corrections or other changes without further notice to this document and any product described herein. Diodes Incorporated does not assume any liability arising out of the application or use of this document or any product described herein; neither does Diodes Incorporated convey any license under its patent or trademark rights, nor the rights of others. Any Customer or user of this document or products described herein in such applications shall assume all risks of such use and will agree to hold Diodes Incorporated and all the companies whose products are represented on Diodes Incorporated website, harmless against all damages.

Diodes Incorporated does not warrant or accept any liability whatsoever in respect of any products purchased through unauthorized sales channel.

Should Customers purchase or use Diodes Incorporated products for any unintended or unauthorized application, Customers shall indemnify and hold Diodes Incorporated and its representatives harmless against all claims, damages, expenses, and attorney fees arising out of, directly or indirectly, any claim of personal injury or death associated with such unintended or unauthorized application.

Products described herein may be covered by one or more United States, international or foreign patents pending. Product names and markings noted herein may also be covered by one or more United States, international or foreign trademarks.

LIFE SUPPORT

Diodes Incorporated products are specifically not authorized for use as critical components in life support devices or systems without the express written approval of the Chief Executive Officer of Diodes Incorporated. As used herein:

A. Life support devices or systems are devices or systems which:

1. are intended to implant into the body, or
2. support or sustain life and whose failure to perform when properly used in accordance with instructions for use provided in the labeling can be reasonably expected to result in significant injury to the user.

B. A critical component is any component in a life support device or system whose failure to perform can be reasonably expected to cause the failure of the life support device or to affect its safety or effectiveness.

Customers represent that they have all necessary expertise in the safety and regulatory ramifications of their life support devices or systems, and acknowledge and agree that they are solely responsible for all legal, regulatory and safety-related requirements concerning their products and any use of Diodes Incorporated products in such safety-critical, life support devices or systems, notwithstanding any devices- or systems-related information or support that may be provided by Diodes Incorporated. Further, Customers must fully indemnify Diodes Incorporated and its representatives against any damages arising out of the use of Diodes Incorporated products in such safety-critical, life support devices or systems.

Copyright © 2011, Diodes Incorporated

www.diodes.com