



Grayhill, Inc.

62S11-H9-025S

Številka dela:

62S11-H9-025S

Proizvajalec / znamka:

Grayhill, Inc.

Opis izdelka

ROTARY ENCODER OPTICAL 32PPR

Podatkovni listi:

 62S11-H9-025S.pdf

Status RoHS

 Brez svinca / RoHS

Iz ladje

Hong Kong

Način pošiljanja

DHL/Fedex/TNT/UPS/EMS

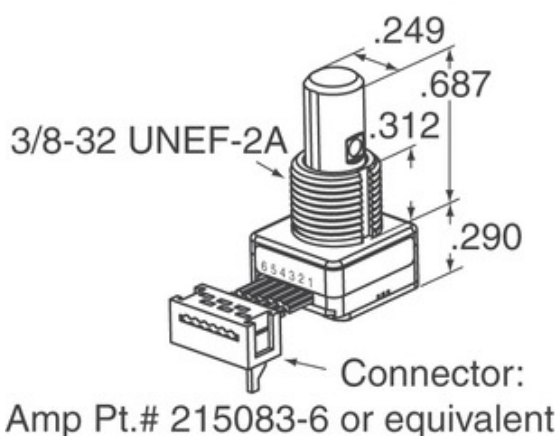

Slika je lahko reprezentativna. Oglejte si specifikacije za podrobnosti izdelka.

[ZAHTEVA ZA PONUDBO](#)



Specifikacije 62S11-H9-025S

ŠTEVILKA DELA	62S11-H9-025S
PROIZVAJALEC	Grayhill, Inc.
OPIS	ROTARY ENCODER OPTICAL 32PPR
STATUS SVOBODNEGA STATUSA / ROHS	Brez svinca / RoHS
PODATKOVNI LIST	 62S11-H9-025S.pdf
NAPETOST - OSKRBA	5V
SKLOP ZAKLJUČKA	Cable Leads
SERIJA	62S
ROTACIJSKO ŽIVLJENJE (CIKLI MIN)	1M
STIKI NA REVOLUCIJO	32
VRSTA IZHODA	Quadrature (Incremental)
DRUGA IMENA	62S11H9025S
USMERJENOST	Vertical
TIP MONTAŽE	Panel Mount
RAVEN OBČUTLJIVOSTI NA VLAGO (MSL)	1 (Unlimited)
PROIZVAJALEC STANDARDNI ČAS VODENJA	8 Weeks
STATUS SVOBODNEGA STATUSA / ROHS	Lead free / RoHS Compliant
TIP DAJALNIKA	Optical
PRIDRŽANJE	Yes
VGRAJEN STIKALO	Yes
TIP AKTUATORJA	1/4" Dia Flatted End

Sorodne oznake

Grayhill, Inc. 62S11-H9-025S	62S11-H9-025S Distributer	62S11-H9-025S Dobavitelj
Cena 62S11-H9-025S	Slika 62S11-H9-025S	Slika 62S11-H9-025S
62S11-H9-025S PDF podatkovni list	62S11-H9-025S Prenos podatkovnega lista	Podatkovni list 62S11-H9-025S
Zaloga 62S11-H9-025S	Nakup 62S11-H9-025S	Kupi Grayhill, Inc. 62S11-H9-025S
Grayhill, Inc. 62S11-H9-025S	Grayhill, Inc. Dobavitelj	Grayhill, Inc. Distributer
Grayhill, Inc. 62S11-H9-025S	Grayhill Inc. 62S11-H9-025S	

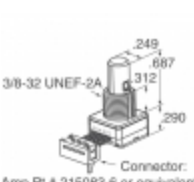
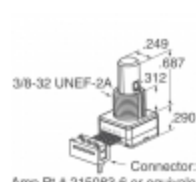
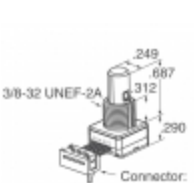
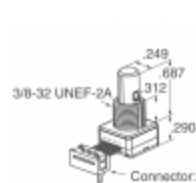
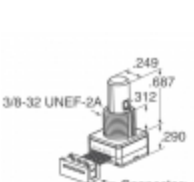
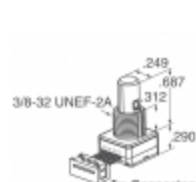
Podobni izdelki

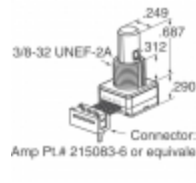
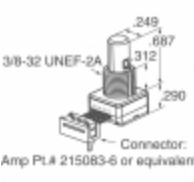
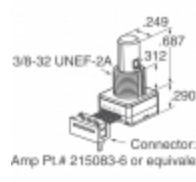
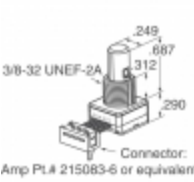
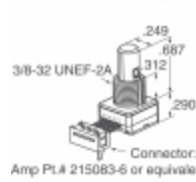
 <p>62S11-H9-060SH Proizvajalci: Grayhill, Inc. Opis: ROTARY ENCODER OPTICAL 32PPR Na zalogi: Out stock</p> <p>RFQ</p>	 <p>62S11-H0-PH Proizvajalci: Grayhill, Inc. Opis: ROTARY ENCODER OPTICAL 32PPR Na zalogi: Out stock</p> <p>RFQ</p>
 <p>62S11-H9-020C Proizvajalci: Grayhill, Inc. Opis: ROTARY ENCODER OPTICAL 32PPR Na zalogi: Out stock</p> <p>RFQ</p>	 <p>62S11-H9-050S Proizvajalci: Grayhill, Inc. Opis: ROTARY ENCODER OPTICAL 32PPR Na zalogi: Out stock</p> <p>RFQ</p>
 <p>62S11-H9-060C Proizvajalci: Grayhill, Inc. Opis: ROTARY ENCODER OPTICAL 32PPR Na zalogi: Out stock</p> <p>RFQ</p>	 <p>62S11-H9-040S Proizvajalci: Grayhill, Inc. Opis: ROTARY ENCODER OPTICAL 32PPR Na zalogi: Out stock</p> <p>RFQ</p>
 <p>62S11-H0-P Proizvajalci: Grayhill, Inc. Opis: ROTARY ENCODER OPT 32PPR 10" CBL Na zalogi: Out stock</p> <p>RFQ</p>	 <p>62S11-H0-200S Proizvajalci: Grayhill, Inc. Opis: ROTARY ENCODER OPTICAL 32PPR Na zalogi: Out stock</p> <p>RFQ</p>
 <p>62S11-H0-060SH Proizvajalci: Grayhill, Inc. Opis: ROTARY ENCODER OPTICAL 32PPR Na zalogi: Out stock</p> <p>RFQ</p>	 <p>62S11-H9-020S Proizvajalci: Grayhill, Inc. Opis: ROTARY ENCODER OPTICAL 32PPR Na zalogi: Out stock</p> <p>RFQ</p>
 <p>62S11-H9-040C Proizvajalci: Grayhill, Inc. Opis: ROTARY ENCODER OPTICAL 32PPR Na zalogi: Out stock</p> <p>RFQ</p>	 <p>62S11-H9-P Proizvajalci: Grayhill, Inc. Opis: ROTARY ENCODER OPTICAL 32PPR Na zalogi: Out stock</p> <p>RFQ</p>