



Grayhill, Inc.

62S11-L0-040C

Številka dela: 62S11-L0-040C

Proizvajalec / znamka: Grayhill, Inc.

Opis izdelka: ROTARY ENCODER OPTICAL 32PPR

Podatkovni listi: [PDF 62S11-L0-040C.pdf](#)Status RoHS:  Brez svinca / RoHS

Iz ladje: Hong Kong

Način pošiljanja: DHL/Fedex/TNT/UPS/EMS

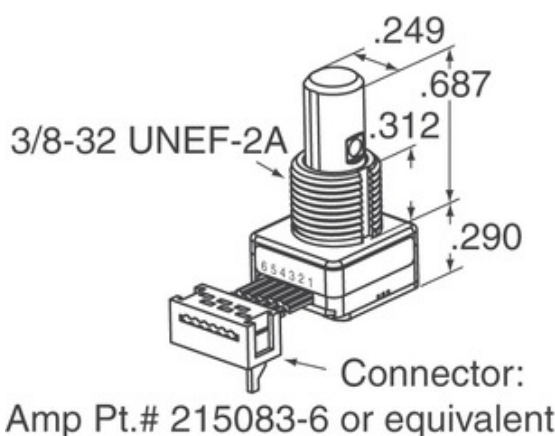

Slika je lahko reprezentativna. Oglejte si specifikacije za podrobnosti izdelka.

[ZAHTEVA ZA PONUDBO](#)





Specifikacije 62S11-L0-040C

ŠTEVILKA DELA	62S11-L0-040C
PROIZVAJALEC	Grayhill, Inc.
OPIS	ROTARY ENCODER OPTICAL 32PPR
STATUS SVOBODNEGA STATUSA / ROHS	Brez svinca / RoHS
PODATKOVNI LIST	PDF 62S11-L0-040C.pdf
NAPETOST - OSKRBA	5V
SKLOP ZAKLJUČKA	Cable with Connector
SERIJA	62S
ROTACIJSKO ŽIVLJENJE (CIKLI MIN)	1M
STIKI NA REVOLUCIJO	32
VRSTA IZHODA	Quadrature (Incremental)
DRUGA IMENA	62S11L0040C
USMERJENOST	Vertical
TIP MONTAŽE	Panel Mount
RAVEN OBČUTLJIVOSTI NA VLAGO (MSL)	1 (Unlimited)
PROIZVAJALEC STANDARDNI ČAS VODENJA	8 Weeks
STATUS SVOBODNEGA STATUSA / ROHS	Lead free / RoHS Compliant
TIP DAJALNIKA	Optical
PRIDRŽANJE	Yes
VGRAJEN STIKALO	No
TIP AKTUATORJA	1/4" Dia Flatted End

Sorodne oznake

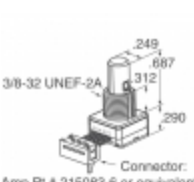
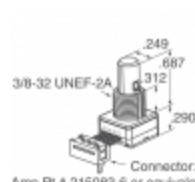
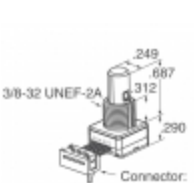
Grayhill, Inc. 62S11-L0-040C	62S11-L0-040C Distributer	62S11-L0-040C Dobavitelj
Cena 62S11-L0-040C	Slike 62S11-L0-040C	Slika 62S11-L0-040C
62S11-L0-040C PDF podatkovni list	62S11-L0-040C Prenos podatkovnega lista	Podatkovni list 62S11-L0-040C
Zaloga 62S11-L0-040C	Nakup 62S11-L0-040C	Kupi Grayhill, Inc. 62S11-L0-040C
Grayhill, Inc. 62S11-L0-040C	Grayhill, Inc. Dobavitelj	Grayhill, Inc. Distributer
Grayhill, Inc. 62S11-L0-040C	Grayhill Inc. 62S11-L0-040C	

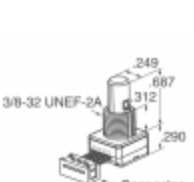
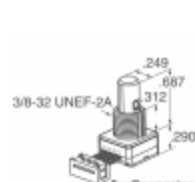
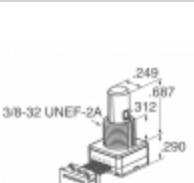
Podobni izdelki

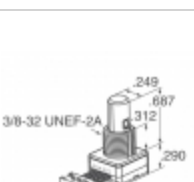
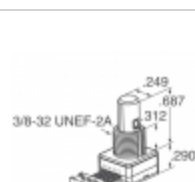
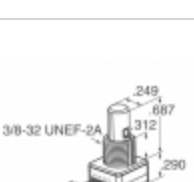
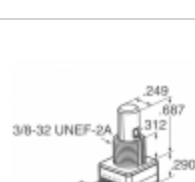
 <p>62S11-L0-P Proizvajalci: Grayhill, Inc. Opis: ROTARY ENCODER OPTICAL 32PPR Na zalogi: Out stock</p> <p>RFQ</p>	 <p>62S11-H9-060SH Proizvajalci: Grayhill, Inc. Opis: ROTARY ENCODER OPTICAL 32PPR Na zalogi: Out stock</p> <p>RFQ</p>
 <p>62S11-L0-055C Proizvajalci: Grayhill, Inc. Opis: ROTARY ENCODER OPTICAL 32PPR Na zalogi: Out stock</p> <p>RFQ</p>	 <p>62S11-L0-040S Proizvajalci: Grayhill, Inc. Opis: ROTARY ENCODER OPT 32PPR 4" CBL Na zalogi: Out stock</p> <p>RFQ</p>
 <p>62S11-H9-060C Proizvajalci: Grayhill, Inc. Opis: ROTARY ENCODER OPTICAL 32PPR Na zalogi: Out stock</p> <p>RFQ</p>	 <p>62S11-L0-060CH Proizvajalci: Grayhill, Inc. Opis: ROTARY ENCODER OPTICAL 32PPR Na zalogi: Out stock</p> <p>RFQ</p>
 <p>62S11-L0-060S Proizvajalci: Grayhill, Inc. Opis: ROTARY ENCODER OPTICAL 32PPR Na zalogi: Out stock</p> <p>RFQ</p>	 <p>62S11-L0-020CH Proizvajalci: Grayhill, Inc. Opis: ROTARY ENCODER OPTICAL 32PPR Na zalogi: Out stock</p> <p>RFQ</p>
 <p>62S11-L0-060SH Proizvajalci: Grayhill, Inc. Opis: ROTARY ENCODER OPTICAL 32PPR Na zalogi: Out stock</p> <p>RFQ</p>	 <p>62S11-H9-PH Proizvajalci: Grayhill, Inc. Opis: ROTARY ENCODER OPTICAL 32PPR Na zalogi: Out stock</p> <p>RFQ</p>
 <p>62S11-L0-020C Proizvajalci: Grayhill, Inc. Opis: ROTARY ENCODER OPTICAL 32PPR Na zalogi: Out stock</p> <p>RFQ</p>	 <p>62S11-H9-P Proizvajalci: Grayhill, Inc. Opis: ROTARY ENCODER OPTICAL 32PPR Na zalogi: Out stock</p> <p>RFQ</p>