



Grayhill, Inc.

62S11-H9-020S

Številka dela:

62S11-H9-020S

Proizvajalec / znamka:

Grayhill, Inc.

Opis izdelka

ROTARY ENCODER OPTICAL 32PPR

Podatkovni listi:

 62S11-H9-020S.pdf

Status RoHS

 Brez svinca / RoHS

Iz ladje

Hong Kong

Način pošiljanja

DHL/Fedex/TNT/UPS/EMS

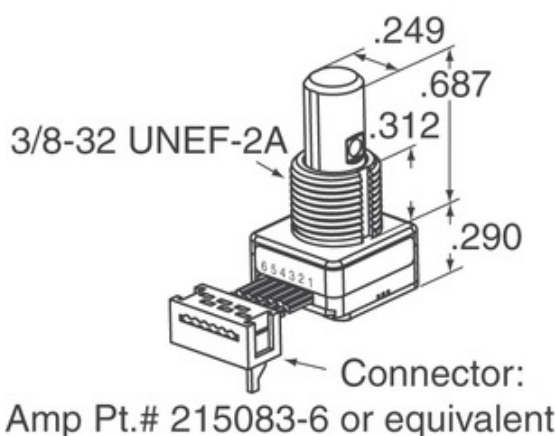

Slika je lahko reprezentativna. Oglejte si specifikacije za podrobnosti izdelka.

[ZAHTEVA ZA PONUDBO](#)



Specifikacije 62S11-H9-020S

| | |
|-------------------------------------|---|
| ŠTEVILKA DELA | 62S11-H9-020S |
| PROIZVAJALEC | Grayhill, Inc. |
| OPIS | ROTARY ENCODER OPTICAL 32PPR |
| STATUS SVOBODNEGA STATUSA / ROHS | Brez svinca / RoHS |
| PODATKOVNI LIST |  62S11-H9-020S.pdf |
| NAPETOST - OSKRBA | 5V |
| SKLOP ZAKLJUČKA | Cable Leads |
| SERIJA | 62S |
| ROTACIJSKO ŽIVLJENJE (CIKLI MIN) | 1M |
| STIKI NA REVOLUCIJO | 32 |
| VRSTA IZHODA | Quadrature (Incremental) |
| DRUGA IMENA | 62S11H9020S |
| USMERJENOST | Vertical |
| TIP MONTAŽE | Panel Mount |
| RAVEN OBČUTLJIVOSTI NA VLAGO (MSL) | 1 (Unlimited) |
| PROIZVAJALEC STANDARDNI ČAS VODENJA | 8 Weeks |
| STATUS SVOBODNEGA STATUSA / ROHS | Lead free / RoHS Compliant |
| TIP DAJALNIKA | Optical |
| PRIDRŽANJE | Yes |
| VGRAJEN STIKALO | Yes |
| TIP AKTUATORJA | 1/4" Dia Flatted End |

Sorodne oznake

| | | |
|-----------------------------------|---|-----------------------------------|
| Grayhill, Inc. 62S11-H9-020S | 62S11-H9-020S Distributer | 62S11-H9-020S Dobavitelj |
| Cena 62S11-H9-020S | Slike 62S11-H9-020S | Slika 62S11-H9-020S |
| 62S11-H9-020S PDF podatkovni list | 62S11-H9-020S Prenos podatkovnega lista | Podatkovni list 62S11-H9-020S |
| Zaloga 62S11-H9-020S | Nakup 62S11-H9-020S | Kupi Grayhill, Inc. 62S11-H9-020S |
| Grayhill, Inc. 62S11-H9-020S | Grayhill, Inc. Dobavitelj | Grayhill, Inc. Distributer |
| Grayhill, Inc. 62S11-H9-020S | Grayhill Inc. 62S11-H9-020S | |

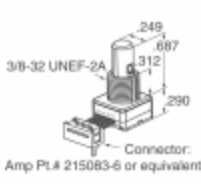
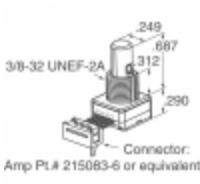
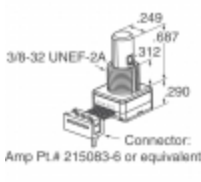
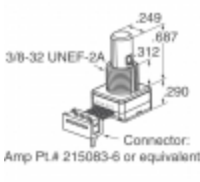
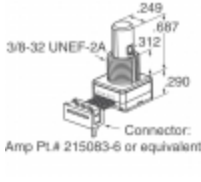
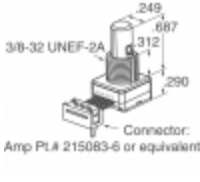
Podobni izdelki

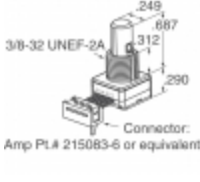
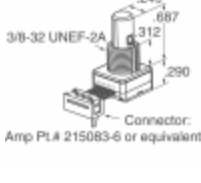
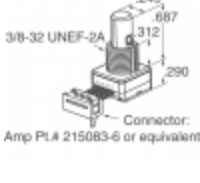
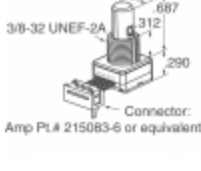
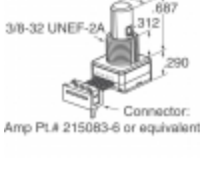
| | |
|--|---|
|  <p>62S11-H0-060SH Proizvajalci: Grayhill, Inc. Opis: ROTARY ENCODER OPTICAL 32PPR Na zalogi: Out stock RFQ</p> |  <p>62S11-H0-PH Proizvajalci: Grayhill, Inc. Opis: ROTARY ENCODER OPTICAL 32PPR Na zalogi: Out stock RFQ</p> |
|  <p>62S11-H9-060C Proizvajalci: Grayhill, Inc. Opis: ROTARY ENCODER OPTICAL 32PPR Na zalogi: Out stock RFQ</p> |  <p>62S11-H0-060C Proizvajalci: Grayhill, Inc. Opis: ROTARY ENCODER OPTICAL 32PPR Na zalogi: Out stock RFQ</p> |
|  <p>62S11-H9-040C Proizvajalci: Grayhill, Inc. Opis: ROTARY ENCODER OPTICAL 32PPR Na zalogi: Out stock RFQ</p> |  <p>62S11-H9-020C Proizvajalci: Grayhill, Inc. Opis: ROTARY ENCODER OPTICAL 32PPR Na zalogi: Out stock RFQ</p> |
|  <p>62S11-H0-P Proizvajalci: Grayhill, Inc. Opis: ROTARY ENCODER OPT 32PPR 10" CBL Na zalogi: Out stock RFQ</p> |  <p>62S11-H9-050S Proizvajalci: Grayhill, Inc. Opis: ROTARY ENCODER OPTICAL 32PPR Na zalogi: Out stock RFQ</p> |
|  <p>62S11-H0-200S Proizvajalci: Grayhill, Inc. Opis: ROTARY ENCODER OPTICAL 32PPR Na zalogi: Out stock RFQ</p> |  <p>62S11-H9-060SH Proizvajalci: Grayhill, Inc. Opis: ROTARY ENCODER OPTICAL 32PPR Na zalogi: Out stock RFQ</p> |
|  <p>62S11-H9-040S Proizvajalci: Grayhill, Inc. Opis: ROTARY ENCODER OPTICAL 32PPR Na zalogi: Out stock RFQ</p> |  <p>62S11-H9-025S Proizvajalci: Grayhill, Inc. Opis: ROTARY ENCODER OPTICAL 32PPR Na zalogi: Out stock RFQ</p> |