



Grayhill, Inc.

## 62S11-H9-050S

Številka dela: 62S11-H9-050S

Proizvajalec / znamka: Grayhill, Inc.

Opis izdelka: ROTARY ENCODER OPTICAL 32PPR

Podatkovni listi: [PDF 62S11-H9-050S.pdf](#)Status RoHS:  Brez svinca / RoHS

Iz ladje: Hong Kong

Način pošiljanja: DHL/Fedex/TNT/UPS/EMS

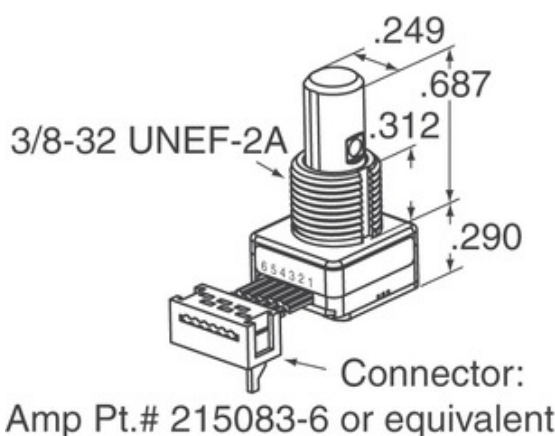

Slika je lahko reprezentativna. Oglejte si specifikacije za podrobnosti izdelka.



### Specifikacije 62S11-H9-050S

ŠTEVILKA DELA	62S11-H9-050S
PROIZVAJALEC	Grayhill, Inc.
OPIS	ROTARY ENCODER OPTICAL 32PPR
STATUS SVOBODNEGA STATUSA / ROHS	Brez svinca / RoHS
PODATKOVNI LIST	<a href="#">PDF 62S11-H9-050S.pdf</a>
NAPETOST - OSKRBA	5V
SKLOP ZAKLJUČKA	Cable Leads
SERIJA	62S
ROTACIJSKO ŽIVLJENJE (CIKLI MIN)	1M
STIKI NA REVOLUCIJO	32
VRSTA IZHODA	Quadrature (Incremental)
DRUGA IMENA	62S11H9050S
USMERJENOST	Vertical
TIP MONTAŽE	Panel Mount
RAVEN OBČUTLJIVOSTI NA VLAGO (MSL)	1 (Unlimited)
PROIZVAJALEC STANDARDNI ČAS VODENJA	8 Weeks
STATUS SVOBODNEGA STATUSA / ROHS	Lead free / RoHS Compliant
TIP DAJALNIKA	Optical
PRIDRŽANJE	Yes
VGRAJEN STIKALO	Yes
TIP AKTUATORJA	1/4" Dia Flatted End

### Sorodne oznake

Grayhill, Inc. 62S11-H9-050S	62S11-H9-050S Distributer	62S11-H9-050S Dobavitelj
Cena 62S11-H9-050S	Slike 62S11-H9-050S	Slika 62S11-H9-050S
62S11-H9-050S PDF podatkovni list	62S11-H9-050S Prenos podatkovnega lista	Podatkovni list 62S11-H9-050S
Zaloga 62S11-H9-050S	Nakup 62S11-H9-050S	Kupi Grayhill, Inc. 62S11-H9-050S
Grayhill, Inc. 62S11-H9-050S	Grayhill, Inc. Dobavitelj	Grayhill, Inc. Distributer
Grayhill, Inc. 62S11-H9-050S	Grayhill Inc. 62S11-H9-050S	

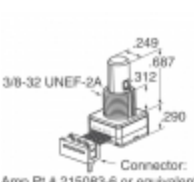
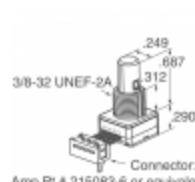
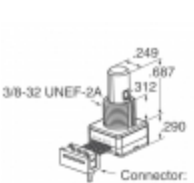
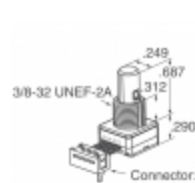
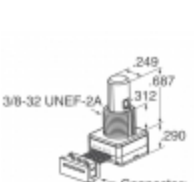
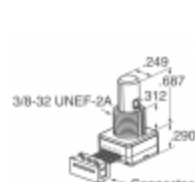
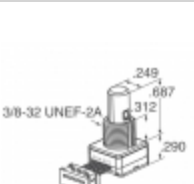
### Podobni izdelki

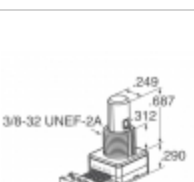
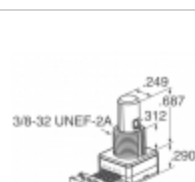
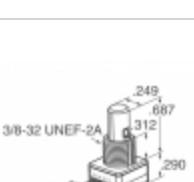
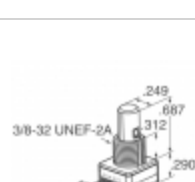
 <p><b>62S11-H9-040C</b> Proizvajalci: Grayhill, Inc. Opis: ROTARY ENCODER OPTICAL 32PPR Na zalogi: Out stock <a href="#">RFQ</a></p>	 <p><b>62S11-H9-040S</b> Proizvajalci: Grayhill, Inc. Opis: ROTARY ENCODER OPTICAL 32PPR Na zalogi: Out stock <a href="#">RFQ</a></p>
 <p><b>62S11-L0-020C</b> Proizvajalci: Grayhill, Inc. Opis: ROTARY ENCODER OPTICAL 32PPR Na zalogi: Out stock <a href="#">RFQ</a></p>	 <p><b>62S11-H9-020C</b> Proizvajalci: Grayhill, Inc. Opis: ROTARY ENCODER OPTICAL 32PPR Na zalogi: Out stock <a href="#">RFQ</a></p>
 <p><b>62S11-H9-PH</b> Proizvajalci: Grayhill, Inc. Opis: ROTARY ENCODER OPTICAL 32PPR Na zalogi: Out stock <a href="#">RFQ</a></p>	 <p><b>62S11-L0-020CH</b> Proizvajalci: Grayhill, Inc. Opis: ROTARY ENCODER OPTICAL 32PPR Na zalogi: Out stock <a href="#">RFQ</a></p>
 <p><b>62S11-H9-P</b> Proizvajalci: Grayhill, Inc. Opis: ROTARY ENCODER OPTICAL 32PPR Na zalogi: Out stock <a href="#">RFQ</a></p>	 <p><b>62S11-H0-PH</b> Proizvajalci: Grayhill, Inc. Opis: ROTARY ENCODER OPTICAL 32PPR Na zalogi: Out stock <a href="#">RFQ</a></p>
 <p><b>62S11-H9-060C</b> Proizvajalci: Grayhill, Inc. Opis: ROTARY ENCODER OPTICAL 32PPR Na zalogi: Out stock <a href="#">RFQ</a></p>	 <p><b>62S11-H9-020S</b> Proizvajalci: Grayhill, Inc. Opis: ROTARY ENCODER OPTICAL 32PPR Na zalogi: Out stock <a href="#">RFQ</a></p>
 <p><b>62S11-H9-060SH</b> Proizvajalci: Grayhill, Inc. Opis: ROTARY ENCODER OPTICAL 32PPR Na zalogi: Out stock <a href="#">RFQ</a></p>	 <p><b>62S11-H9-025S</b> Proizvajalci: Grayhill, Inc. Opis: ROTARY ENCODER OPTICAL 32PPR Na zalogi: Out stock <a href="#">RFQ</a></p>