



Coto Technology

7301-05-1010

Številka dela:

Proizvajalec / znamka:

Opis izdelka

Podatkovni listi:

Status RoHS

Iz ladje

Način pošiljanja

7301-05-1010

Coto Technology

RELAY REED SPST 500MA 5V

 7301-05-1010.pdf

 Brez svınca / RoHS

Hong Kong

DHL/Fedex/TNT/UPS/EMS

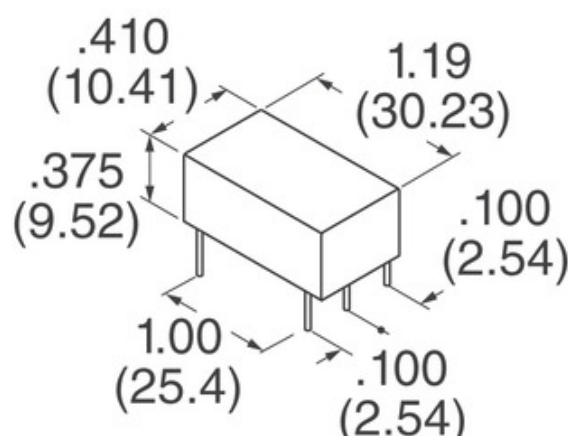

Slika je lahko reprezentativna. Oglejte si specifikacije za podrobnosti izdelka.

[ZAHTEVA ZA PONUDBO](#)







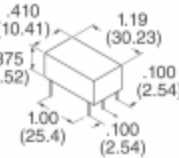
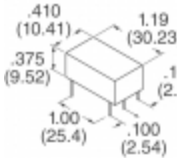

Specifikacije 7301-05-1010

ŠTEVILKA DELA	7301-05-1010
PROIZVAJALEC	Coto Technology
OPIS	RELAY REED SPST 500MA 5V
STATUS SVOBODNEGA STATUSA / ROHS	Brez svınca / RoHS
PODATKOVNI LIST	 7301-05-1010.pdf
VKLOPITE NAPETOST (MAKS.)	3.75 VDC
IZKLOP NAPETOSTI (MIN)	0.4 VDC
SKLOP ZAKLJUČKA	PC Pin
PREKLOPNA NAPETOST	500VAC, 500VDC - Max
SERIJA	7000
ČAS IZDAJE	0.1ms
PAKIRANJE	Tube
DELOVNA TEMPERATURA	-20°C ~ 85°C
ČAS DELOVANJA	1ms
TIP MONTAŽE	Through Hole
RAVEN OBČUTLJIVOSTI NA VLAGO (MSL)	1 (Unlimited)
PROIZVAJALEC STANDARDNI ČAS VODENJA	28 Weeks
STATUS SVOBODNEGA STATUSA / ROHS	Lead free / RoHS Compliant
LASTNOSTI	Electrostatic Shield
OCENA STIKA (TRENUTNA)	500mA
KONTAKTNI MATERIAL	-
KONTAKTNI OBRAZEC	SPST-NO (1 Form A)
NAPETOST TULJAVE	5VDC
VRSTA TULJAVE	Non Latching
ODPORNOST NA KOLUT	175 Ohms
MOČ TULJAVE	-
TOK TEKOČINE	28.6mA

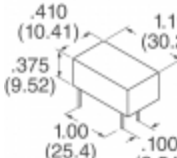
Sorodne oznake

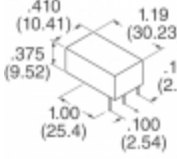
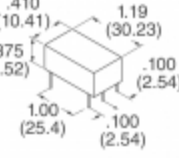
Coto Technology 7301-05-1010	7301-05-1010 Distributer	7301-05-1010 Dobavitelj
Cena 7301-05-1010	Slike 7301-05-1010	Slika 7301-05-1010
7301-05-1010 PDF podatkovni list	7301-05-1010 Prenos podatkovnega lista	Podatkovni list 7301-05-1010
Zaloga 7301-05-1010	Nakup 7301-05-1010	Kupi Coto Technology 7301-05-1010
Coto Technology 7301-05-1010	Coto Technology Dobavitelj	Coto Technology Distributer
Coto Technology 7301-05-1010		

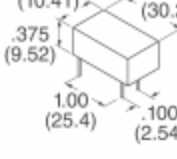
Podobni izdelki

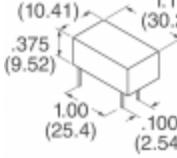
 <p>7301-05-1011 Proizvajalci: Coto Technology Opis: RELAY REED SPST 500MA 5V Na zalogi: Out stock</p> <p>RFQ</p>	 <p>7301-12-1010 Proizvajalci: Coto Technology Opis: RELAY REED SPST 500MA 12V Na zalogi: Out stock</p> <p>RFQ</p>
 <p>7301-05-1110 Proizvajalci: Coto Technology Opis: RELAY REED SPST 500MA 5V Na zalogi: 137 pcs</p> <p>RFQ</p>	 <p>7301-05-1001 Proizvajalci: Coto Technology Opis: RELAY REED SPST 500MA 5V Na zalogi: Out stock</p> <p>RFQ</p>
 <p>73009W 0081000 Proizvajalci: Belden Opis: CBL 9COND 20AWG Na zalogi: Out stock</p> <p>RFQ</p>	 <p>7301-05-1100 Proizvajalci: Coto Technology Opis: RELAY REED SPST 500MA 5V Na zalogi: Out stock</p> <p>RFQ</p>
 <p>7301-12-1011 Proizvajalci: Coto Technology Opis: RELAY REED SPST 500MA 12V Na zalogi: Out stock</p> <p>RFQ</p>	 <p>73009W 008100 Proizvajalci: Belden Opis: CBL 9COND 20AWG Na zalogi: Out stock</p> <p>RFQ</p>
 <p>73009W 008500 Proizvajalci: Belden Opis: CBL 9COND 20AWG Na zalogi: Out stock</p> <p>RFQ</p>	 <p>7301-12-1000 Proizvajalci: Coto Technology Opis: RELAY REED SPST 500MA 12V Na zalogi: Out stock</p> <p>RFQ</p>
 <p>7300N Proizvajalci: Apex Tool Group Opis: AO102 ARBOR MT/JT Na zalogi: Out stock</p> <p>RFQ</p>	 <p>7301-05-1000 Proizvajalci: Coto Technology Opis: RELAY REED SPST 500MA 5V Na zalogi: 144 pcs</p> <p>RFQ</p>